



# Vehicle History Report™

US \$44.99

## 1999 TOYOTA LAND CRUISER

VIN: JT3HT05J3X0039305  
 4 DOOR WAGON/SPORT UTILITY  
 4.7L V8 F DOHC 32V GASOLINE  
 ALL WHEEL DRIVE

**Damage reported: minor damage**

**36** Service history records

**3** Previous owners

Personal vehicle

**138,697** Last reported odometer reading



This CARFAX Vehicle History Report is based only on information supplied to CARFAX and available as of 9/6/25 at 3:09:10 PM (CDT). Other information about this vehicle, including problems, may not have been reported to CARFAX. Use this report as one important tool, along with a vehicle inspection and test drive, to make a better decision about your next used car.



## Accident / Damage History

Not all accidents / issues are reported to CARFAX

### Event 1

10/23/2020

**Damage reported: minor damage**

**Damage Severity Scale**

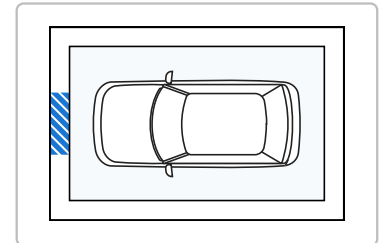

## Additional History

Not all accidents / issues are reported to CARFAX

|  | Owner 1            | Owner 2            | Owner 3            |
|--|--------------------|--------------------|--------------------|
| <b>Total Loss</b><br>No total loss reported to CARFAX.   | No Issues Reported | No Issues Reported | No Issues Reported |
| <b>Structural Damage</b><br>CARFAX recommends that you have this vehicle inspected by a collision repair specialist. | No Issues Reported | No Issues Reported | No Issues Reported |

|  |   |   |   |
|--|---|---|---|
| <b>Airbag Deployment</b><br>No airbag deployment reported to CARFAX.                     | <input checked="" type="checkbox"/> No Issues Reported  | <input checked="" type="checkbox"/> No Issues Reported  | <input checked="" type="checkbox"/> No Issues Reported  |
| <b>Odometer Check</b><br>No indication of an odometer rollback.                          | <input checked="" type="checkbox"/> No Issues Indicated | <input checked="" type="checkbox"/> No Issues Indicated | <input checked="" type="checkbox"/> No Issues Indicated |
| <b>Accident / Damage</b><br>Damage reported: 10/23/2020.                                 | <input checked="" type="checkbox"/> No Issues Reported  | Minor Damage  | No New Issues Reported                                  |
| <b>Manufacturer Recall</b><br>No open recalls reported to CARFAX. View Toyota disclosure | <input checked="" type="checkbox"/> No Recalls Reported | <input checked="" type="checkbox"/> No Recalls Reported | <input checked="" type="checkbox"/> No Recalls Reported |
| <b>Basic Warranty</b><br>Original warranty estimated to have expired.                    | <b>Warranty Expired</b>                                 | <b>Warranty Expired</b>                                 | <b>Warranty Expired</b>                                 |

|  |                |                |                |
|--|----------------|----------------|----------------|
| <b>CARFAX Title History</b>  | <b>Owner 1</b> | <b>Owner 2</b> | <b>Owner 3</b> |
| <b>Damage Brands</b><br>Salvage   Junk   Rebuilt   Fire   Flood   Hail   Lemon | No Problem     | No Problem     | No Problem     |
| <b>Odometer Brands</b><br>Not Actual Mileage   Exceeds Mechanical Limits       | No Problem     | No Problem     | No Problem     |

|  |                |                |                |
|--|----------------|----------------|----------------|
| <b>CARFAX Ownership History</b><br>The number of owners is estimated | <b>Owner 1</b> | <b>Owner 2</b> | <b>Owner 3</b> |
| Year purchased   | 1999           | 2020           | 2021           |
| Type of owner  | Personal       | Personal       | Personal       |
| Estimated length of ownership  | 20 yrs. 6 mo.  | 6 months       | 1 yr. 6 mo.    |
| Owned in the following states/provinces                              | Illinois       | California     | California     |
| Estimated miles driven per year                                      | 5,936/yr       | --             | --             |
| Last reported odometer reading                                       | 121,913        | 126,835        | 138,697        |

**CARFAX Detailed History**





 **Owner 1**  
Purchased: 1999



**Low mileage!** This owner drove less than the industry average of 15,000 miles per year.

Personal Vehicle  
5,936 mi/yr

| Date | Mileage | Source | Comments |
|------|---------|--------|----------|
|      |         |        |          |

|            |        |  |   |  |
|------------|--------|--|---|--|
| 12/05/1998 |        | NICB   |   | <b>Vehicle manufactured and shipped to original dealer</b>                                 |
| 12/08/1999 |        | Illinois<br>Motor Vehicle Dept.<br>Buffalo Grove, IL   |   | <b>Titled or registered as personal vehicle</b>  |
| 01/28/2000 | 22,900 | Illinois<br>Motor Vehicle Dept.<br>Schaumburg, IL  |   | <b>Title or registration issued</b><br>- Title issued or updated<br>- First owner reported |
| 08/26/2000 | 28,480 | Woodfield Lexus<br>Schaumburg, IL<br>847-882-0200<br>woodfieldlexus.com<br>★ 4.7 / 5.0<br>379 Verified Reviews<br>❤️ 255 Customer Favorites              |    | <b>Vehicle serviced</b>  |
| 02/20/2001 |        | Illinois<br>Motor Vehicle Dept.<br>Buffalo Grove, IL   |   | <b>Title issued or updated</b><br>- Correction to record                                   |
| 02/28/2001 | 31,863 | Arlington Toyota, Inc<br>Buffalo Grove, IL<br>847-394-5100<br>arlington-toyota.com<br>★ 4.5 / 5.0<br>893 Verified Reviews<br>❤️ 4,738 Customer Favorites |    | <b>Vehicle serviced</b><br>- Body electrical system checked                                |
| 03/09/2001 | 32,010 | Arlington Toyota, Inc<br>Buffalo Grove, IL<br>847-394-5100<br>arlington-toyota.com<br>★ 4.5 / 5.0<br>893 Verified Reviews<br>❤️ 4,738 Customer Favorites |  | <b>Vehicle serviced</b><br>- Recommended maintenance performed                             |
| 06/23/2001 | 33,620 | Arlington Toyota, Inc<br>Buffalo Grove, IL<br>847-394-5100<br>arlington-toyota.com<br>★ 4.5 / 5.0<br>893 Verified Reviews<br>❤️ 4,738 Customer Favorites |  | <b>Vehicle serviced</b><br>- Oil and filter changed  |
| 07/07/2001 | 33,794 | Arlington Toyota, Inc<br>Buffalo Grove, IL<br>847-394-5100<br>arlington-toyota.com   |  | <b>Vehicle serviced</b><br>- Body electrical system checked                                |

★ 4.5 / 5.0  
 893 Verified Reviews  
 ❤️ 4,738 Customer Favorites

07/20/2001

Arlington Toyota, Inc  
 Buffalo Grove, IL  
 847-394-5100  
 arlington-toyota.com



**Vehicle serviced**  
 - Radio/sound system checked

★ 4.5 / 5.0  
 893 Verified Reviews  
 ❤️ 4,738 Customer Favorites

09/18/2001 34,915

Arlington Toyota, Inc  
 Buffalo Grove, IL  
 847-394-5100  
 arlington-toyota.com



**Vehicle serviced**  
 - Radio/sound system checked

★ 4.5 / 5.0  
 893 Verified Reviews  
 ❤️ 4,738 Customer Favorites

12/11/2001 35,792

Arlington Toyota, Inc  
 Buffalo Grove, IL  
 847-394-5100  
 arlington-toyota.com



**Vehicle serviced**  
 - Radio/sound system checked

★ 4.5 / 5.0  
 893 Verified Reviews  
 ❤️ 4,738 Customer Favorites

04/04/2002

AutoNation Toyota  
 Libertyville  
 Libertyville, IL  
 847-362-1500  
 autonationtoyotalibertyville.com



**Vehicle serviced**  
 - Oil and filter changed

★ 4.3 / 5.0  
 415 Verified Reviews  
 ❤️ 346 Customer Favorites

07/17/2002 40,113

Arlington Toyota, Inc  
 Buffalo Grove, IL  
 847-394-5100  
 arlington-toyota.com







**Vehicle serviced**

★ 4.5 / 5.0  
 893 Verified Reviews  
 ❤️ 4,738 Customer Favorites

06/18/2003 41,000

Illinois  
 Inspection Station  
 Lincolnshire, IL





**Passed emissions inspection**

|            |        |   |  |
|------------|--------|---|--|
| 07/02/2004 | 43,668 | Arlington Toyota, Inc<br>Buffalo Grove, IL<br>847-394-5100<br>arlington-toyota.com<br>★ 4.5 / 5.0<br>893 Verified Reviews<br>❤️ 4,738 Customer Favorites                      |  <b>Vehicle serviced</b><br>- Oil and filter changed  |
| 04/01/2005 | 45,000 | Illinois<br>Inspection Station<br>Lincolnshire, IL  | <b>Passed emissions inspection</b>   |
| 04/09/2005 | 45,285 | Arlington Toyota, Inc<br>Buffalo Grove, IL<br>847-394-5100<br>arlington-toyota.com<br>★ 4.5 / 5.0<br>893 Verified Reviews<br>❤️ 4,738 Customer Favorites                      |  <b>Vehicle serviced</b><br>- Radio/sound system checked  |
| 04/06/2007 | 49,000 | Illinois<br>Inspection Station<br>Lincolnshire, IL  | <b>Passed emissions inspection</b>   |
| 02/21/2009 | 55,507 | AutoNation Toyota<br>Libertyville<br>Libertyville, IL<br>847-362-1500<br>autonationtoyotalibertyville.com<br>★ 4.3 / 5.0<br>415 Verified Reviews<br>❤️ 346 Customer Favorites |  <b>Vehicle serviced</b><br>- Maintenance inspection completed<br>- Recommended maintenance performed<br>- Alignment checked<br>- Maintenance reminder reset<br>- Oil and filter changed<br>- Tire condition and pressure checked<br>- Tire(s) replaced |
| 09/15/2009 | 56,000 | Illinois<br>Inspection Station<br>Lincolnshire, IL  | <b>Passed emissions inspection</b>   |
| 11/13/2009 |        | Illinois<br>Motor Vehicle Dept.<br>Glenview, IL   | <b>Registration issued or renewed</b><br>- Registration updated when owner moved the vehicle to a new location   |
| 11/16/2010 |        | Illinois<br>Motor Vehicle Dept.<br>Glenview, IL   | <b>Registration issued or renewed</b>  |
| 11/29/2010 | 60,801 | AutoNation Toyota<br>Libertyville<br>Libertyville, IL<br>847-362-1500<br>autonationtoyotalibertyville.com   |  <b>Vehicle serviced</b><br>- Oil and filter changed<br>- Tire condition and pressure checked   |





★ 4.3 / 5.0

415 Verified Reviews

♥ 346 Customer Favorites

|            |        |   |   |   |
|------------|--------|---|---|---|
| 08/25/2011 | 63,678 | Arlington Toyota, Inc<br>Buffalo Grove, IL<br>847-394-5100<br>arlington-toyota.com                        |    | <b>Vehicle serviced</b>   |
|            |        | ★ 4.5 / 5.0<br>893 Verified Reviews<br>♥ 4,738 Customer Favorites   |   |   |
| 09/03/2011 |        | Illinois<br>Inspection Station<br>Lincolnshire, IL  |   | <b>Passed emissions inspection</b>  |
| 11/09/2011 |        | Illinois<br>Motor Vehicle Dept.<br>Glenview, IL   |   | <b>Registration issued or renewed</b>   |
| 01/03/2012 | 64,472 | AutoNation Toyota<br>Libertyville<br>Libertyville, IL<br>847-362-1500<br>autonationtoyotalibertyville.com |    | <b>Vehicle serviced</b><br>- Maintenance inspection completed<br>- Battery/charging system checked<br>- Brakes checked<br>- Exhaust system checked<br>- Oil and filter changed<br>- Tire condition and pressure checked                       |
|            |        | ★ 4.3 / 5.0<br>415 Verified Reviews<br>♥ 346 Customer Favorites   |   |   |
| 01/13/2012 | 64,548 | Arlington Toyota, Inc<br>Buffalo Grove, IL<br>847-394-5100<br>arlington-toyota.com                        |  | <b>Vehicle serviced</b><br>- Differential serviced<br>- Drive belt(s) replaced<br>- Exhaust system checked<br>- Rear differential fluid flushed/changed<br>- Timing belt replaced<br>- Transfer case serviced<br>- Transmission fluid flushed |
|            |        | ★ 4.5 / 5.0<br>893 Verified Reviews<br>♥ 4,738 Customer Favorites   |   |   |
| 11/14/2012 |        | Illinois<br>Motor Vehicle Dept.<br>Glenview, IL   |   | <b>Registration issued or renewed</b>   |
| 01/09/2013 | 66,780 | Toyota on Edens<br>Northbrook, IL<br>847-272-0808<br>toyotaonedens.com/                                   |  | <b>Vehicle serviced</b><br>- Starter replaced<br>- Vehicle washed/detailed  |
|            |        | ★ 4.7 / 5.0<br>510 Verified Reviews<br>♥ 1,191 Customer Favorites   |   |   |
| 09/11/2013 | 68,000 | Illinois  |   | <b>Passed emissions inspection</b>  |





Inspection Station  
Skokie, IL





|            |        |  |   |  |
|------------|--------|--|---|--|
| 11/04/2013 |        | Illinois<br>Motor Vehicle Dept.<br>Glenview, IL  |   | <b>Registration issued or renewed</b>  |
| 11/07/2013 | 68,884 | Toyota on Edens<br>Northbrook, IL<br>847-272-0808<br>toyotaonedens.com/<br>★ 4.7 / 5.0<br>510 Verified Reviews<br>♥ 1,191 Customer Favorites |    | <b>Vehicle serviced</b><br>- Maintenance inspection completed<br>- Oil and filter changed<br>- Vehicle washed/detailed   |
| 09/11/2014 | 73,845 | Toyota on Edens<br>Northbrook, IL<br>847-272-0808<br>toyotaonedens.com/<br>★ 4.7 / 5.0<br>510 Verified Reviews<br>♥ 1,191 Customer Favorites |    | <b>Vehicle serviced</b><br>- Maintenance inspection completed<br>- Floor mats installed<br>- Oil and filter changed<br>- Vehicle washed/detailed                               |
| 11/18/2014 |        | Illinois<br>Motor Vehicle Dept.<br>Glenview, IL  |   | <b>Registration issued or renewed</b>  |
| 09/03/2015 | 83,000 | Illinois<br>Inspection Station<br>Skokie, IL   |   | <b>Passed emissions inspection</b>   |
| 09/14/2015 | 84,270 | Toyota on Edens<br>Northbrook, IL<br>847-272-0808<br>toyotaonedens.com/<br>★ 4.7 / 5.0<br>510 Verified Reviews<br>♥ 1,191 Customer Favorites |  | <b>Vehicle serviced</b><br>- Maintenance inspection completed<br>- Oil and filter changed<br>- Vehicle washed/detailed   |
| 10/09/2015 | 84,992 | Midas<br>Highland Park, IL<br>847-831-5000<br>midas.com<br>★ 4.7 / 5.0<br>57 Verified Reviews<br>♥ 42 Customer Favorites                     |  | <b>Vehicle serviced</b><br>- Brakes checked<br>- Brake pads replaced<br>- Brakes replaced<br>- Brakes serviced<br>- Rear brake pads replaced<br>- Rear brake rotor(s) replaced |
| 10/15/2015 |        | Toyota on Edens<br>Northbrook, IL<br>847-272-0808<br>toyotaonedens.com/  |  | <b>Vehicle serviced</b>  |

★ 4.7 / 5.0

510 Verified Reviews

♥ 1,191 Customer Favorites

|            |        |  |   |   |
|------------|--------|--|---|---|
| 12/08/2015 |        | Illinois<br>Motor Vehicle Dept.<br>Glenview, IL  |   | <b>Registration issued or renewed</b>   |
| 03/28/2016 | 89,533 | Toyota on Edens<br>Northbrook, IL<br>847-272-0808<br><a href="https://toyotaonedens.com/">https://toyotaonedens.com/</a> |    | <b>Vehicle serviced</b><br>- Maintenance inspection completed<br>- Oil and filter changed   |
|            |        | ★ 4.7 / 5.0<br>510 Verified Reviews  |   |   |
|            |        | ♥ 1,191 Customer Favorites   |   |   |
| 10/28/2016 | 94,892 | Toyota on Edens<br>Northbrook, IL<br>847-272-0808<br><a href="https://toyotaonedens.com/">https://toyotaonedens.com/</a> |    | <b>Vehicle serviced</b><br>- Maintenance inspection completed<br>- Oil and filter changed   |
|            |        | ★ 4.7 / 5.0<br>510 Verified Reviews  |   |   |
|            |        | ♥ 1,191 Customer Favorites   |   |   |
| 11/12/2016 |        | Illinois<br>Motor Vehicle Dept.<br>Glenview, IL  |   | <b>Registration issued or renewed</b>   |
| 12/13/2016 | 96,020 | Midas<br>Highland Park, IL<br>847-831-5000<br>midas.com  |  | <b>Vehicle serviced</b><br>- Brake pads replaced<br>- Brakes replaced<br>- Front brake pads replaced<br>- Front brake rotor(s) replaced |
|            |        | ★ 4.7 / 5.0<br>57 Verified Reviews   |   |   |
|            |        | ♥ 42 Customer Favorites  |   |   |
| 04/25/2017 | 99,846 | Toyota on Edens<br>Northbrook, IL<br>847-272-0808<br><a href="https://toyotaonedens.com/">https://toyotaonedens.com/</a> |  | <b>Vehicle serviced</b><br>- Maintenance inspection completed   |
|            |        | ★ 4.7 / 5.0<br>510 Verified Reviews  |   |   |
|            |        | ♥ 1,191 Customer Favorites   |   |   |
| 09/29/2017 |        | Illinois<br>Inspection Station<br>Skokie, IL   |   | <b>Passed emissions inspection</b>  |

|            |         |  |   |   |
|------------|---------|--|---|---|
| 10/03/2017 |         | Illinois<br>Motor Vehicle Dept.<br>Glenview, IL  |   | <b>Registration issued or renewed</b>   |
| 10/10/2017 | 102,500 | Meineke Car Care Center<br>Des Plaines, IL<br>847-375-9505<br>meineke.com<br>★ 4.6 / 5.0<br>41 Verified Reviews<br>♥ 132 Customer Favorites          |    | <b>Vehicle serviced</b><br>- Exhaust system checked                                       |
| 03/06/2018 | 105,512 | Toyota on Edens<br>Northbrook, IL<br>847-272-0808<br>https://toyotaonedens.com/<br>★ 4.7 / 5.0<br>510 Verified Reviews<br>♥ 1,191 Customer Favorites |    | <b>Vehicle serviced</b><br>- Maintenance inspection completed<br>- Oil and filter changed |
| 11/11/2018 |         | Illinois<br>Motor Vehicle Dept.<br>Glenview, IL  |   | <b>Registration issued or renewed</b><br>- Correction to record                           |
| 01/08/2019 | 110,515 | Toyota on Edens<br>Northbrook, IL<br>847-272-0808<br>https://toyotaonedens.com/<br>★ 4.7 / 5.0<br>510 Verified Reviews<br>♥ 1,191 Customer Favorites |  | <b>Vehicle serviced</b><br>- Maintenance inspection completed<br>- Oil and filter changed |
| 06/26/2019 | 112,000 | Meineke Car Care Center<br>Des Plaines, IL<br>847-375-9505<br>meineke.com<br>★ 4.6 / 5.0<br>41 Verified Reviews<br>♥ 132 Customer Favorites          |  | <b>Vehicle serviced</b><br>- Starter replaced   |
| 08/20/2019 | 115,160 | Toyota on Edens<br>Northbrook, IL<br>847-272-0808<br>https://toyotaonedens.com/<br>★ 4.7 / 5.0<br>510 Verified Reviews<br>♥ 1,191 Customer Favorites |  | <b>Vehicle serviced</b><br>- Maintenance inspection completed<br>- Oil and filter changed |

|            |         |   |  |
|------------|---------|---|--|
| 09/23/2019 | 116,000 | Illinois<br>Inspection Station<br>Lincolnshire, IL  | <b>Passed emissions inspection</b>   |
| 11/09/2019 |         | Illinois<br>Motor Vehicle Dept.<br>Glenview, IL   | <b>Registration issued or renewed</b>  |
| 12/19/2019 | 118,488 | Toyota on Edens<br>Northbrook, IL<br>847-272-0808<br><a href="https://toyotaonedens.com/">https://toyotaonedens.com/</a><br>★ <b>4.7 / 5.0</b><br>510 Verified Reviews<br>♥ <b>1,191</b> Customer Favorites |  <b>Vehicle serviced</b><br>- Maintenance inspection completed<br>- Oil and filter changed<br>- Steering/suspension checked |
| 06/16/2020 | 121,913 | California<br>Inspection Station<br>Los Angeles, CA   | <b>Passed emissions inspection</b>   |

 **Owner 2** Personal Vehicle  
Purchased: 2020

| Date       | Mileage | Source   | Comments  |
|------------|---------|--|---|
| 06/16/2020 | 122,000 | California<br>Motor Vehicle Dept.<br>Los Angeles, CA | <b>Title issued or updated</b><br>- New owner reported  |
| 10/23/2020 |         | Damage Report  | <div data-bbox="852 1207 901 1270" style="display: inline-block; border: 1px solid black; border-radius: 50%; width: 20px; height: 20px; text-align: center; line-height: 20px; background-color: #e0e0e0;">i</div> <b>Damage reported: minor damage</b><br>- Damage to front |

**Damage Severity Scale**

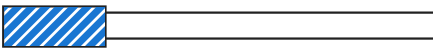

MINOR                      MODERATE                      SEVERE

**Damage Location**

FRONT

LEFT
RIGHT

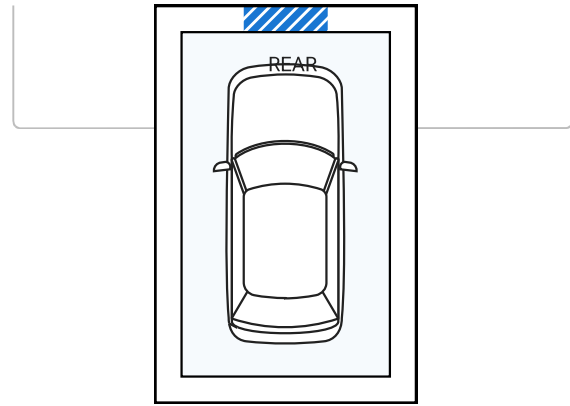





Minor damage is usually cosmetic, including dents or scratches to the vehicle body.

|            |         |   |                                    |
|------------|---------|---|------------------------------------|
| 01/11/2021 | 126,000 | AAA Motor Cars<br>Chatsworth, CA<br>★ 4.6 / 5.0<br>8 Verified Reviews | <b>Vehicle offered for sale</b>    |
| 01/12/2021 | 126,835 | California<br>Inspection Station<br>Reseda, CA                        | <b>Passed emissions inspection</b> |

 **Owner 3** Personal Vehicle  
Purchased: 2021

| Date       | Mileage | Source   | Comments   |
|------------|---------|--|--|
| 03/24/2021 |         | California<br>Motor Vehicle Dept.<br>Los Angeles, CA   | <b>Title issued or updated</b><br>- New owner reported |
| 08/26/2022 | 130,187 | California<br>Inspection Station<br>Midway City, CA  | <b>Passed emissions inspection</b>                     |
| 10/19/2022 |         | AAA Motor Cars<br>Chatsworth, CA<br>818-359-7890<br>aaamotorcars.com/<br>★ 4.6 / 5.0<br>8 Verified Reviews | <b>Vehicle offered for sale</b>                        |

|   |   |   |   |  |
|---|---|---|---|--|
| 01/06/2023  | 130,907   | Buellton Garage<br>Automotive Repair<br>Buellton, CA<br>805-688-3444<br>buelltongarage.com/ |   | <b>Vehicle serviced</b><br>- Brakes checked  |
|   |   | ★ 5.0 / 5.0<br>27 Verified Reviews<br>❤️ 8 Customer Favorites                               |   |  |
| 03/26/2024  | California<br>Motor Vehicle Dept.<br>Santa Ynez, CA |   | <b>Registration updated when owner moved the vehicle to a new location</b>  |  |
| 10/09/2024  | 138,637   | LUNDE'S SOLVANG AUTO REPAIR<br>Solvang, CA<br>805-688-4716<br>lundessolvangautocare.com/    |    | <b>Vehicle serviced</b><br>- Emissions inspection performed                                      |
|   |   | ★ 5.0 / 5.0<br>46 Verified Reviews<br>❤️ 18 Customer Favorites                              |   |  |
| 10/09/2024  | California<br>Inspection Station<br>Solvang, CA     |   | <b>Passed emissions inspection</b>  |  |
| 10/29/2024  | 138,697   | Valley Automotive Llc<br>Buellton, CA<br>805-688-0579<br>valleyauto.mechanicnet.com/        |    | <b>Vehicle serviced</b><br>- Pinion seal(s) replaced<br>- Rear differential pinion seal replaced |
|   |   | ★ 5.0 / 5.0<br>14 Verified Reviews  |   |  |
| 09/06/2025  | CARFAX Car Care                                     |   | <b>Manufacturer Recommended Maintenance Schedules</b>   |  |
|  |   |   | Get this vehicle's maintenance schedule, service history and recall alerts at <a href="https://www.carfax.com/service">carfax.com/service</a> . |  |

Have Questions? Please visit our Help Center at [www.carfax.com](https://www.carfax.com).



## Glossary

### Damage Indicator

Damage can be a result of many different types of events. Examples include contact with objects (other cars, trees, traffic signs, road debris, etc), vandalism, or weather-related events. Not every damage event is reported to CARFAX. As details about the damage event become available, those additional details are added to the CARFAX Vehicle History Report. CARFAX recommends that you have this vehicle inspected by a qualified mechanic.

- This CARFAX Vehicle History Report is based only on information supplied to CARFAX and available as of 9/6/25 at 3:09:10 PM (CDT). Other information about this vehicle, including problems, may not have been reported to CARFAX. Use this report as one important tool, along with a vehicle inspection and test drive, to make a better decision about your next used car.

### Damage Severity

Damage events result in one of the following severity levels:

- Minor: Generally, minor damage is cosmetic (including dents or scratches), may only require reconditioning, and typically does not compromise a vehicle's operation and/or safety.
- Moderate: Moderate damage may affect multiple components of the vehicle and may impair the vehicle's operation and/or safety.
- Severe: Severe damage usually affects multiple components of the vehicle and is likely to compromise the vehicle's operation and/or safety.

CARFAX recommends getting a pre-purchase inspection at a certified collision repair facility.

### First Owner

When the first owner(s) obtains a title from a Department of Motor Vehicles as proof of ownership.

### New Owner Reported

When a vehicle is sold to a new owner, the Title must be transferred to the new owner(s) at a Department of Motor Vehicles.

### Ownership History

CARFAX defines an owner as an individual or business that possesses and uses a vehicle. Not all title transactions represent changes in ownership. To provide estimated number of owners, CARFAX proprietary technology analyzes all the events in a vehicle history. Estimated ownership is available for vehicles manufactured after 1991 and titled solely in the US including Puerto Rico. Dealers sometimes opt to take ownership of a vehicle and are required to in the following states: Maine, Massachusetts, New Jersey, Ohio, Oklahoma, Pennsylvania and South Dakota. Please consider this as you review a vehicle's estimated ownership history.

### Title Issued

A state issues a title to provide a vehicle owner with proof of ownership. Each title has a unique number. Each title or registration record on a CARFAX report does not necessarily indicate a change in ownership. In Canada, a registration and bill of sale are used as proof of ownership.

### Toyota Recall / Service Campaign

Portions of this report have been included under license from Toyota Motor North America, Inc. ("TOYOTA"), License Agreement TMS1013 . This data applies only to vehicle marketed or originally sold in Mexico and the United States of America, including Guam, Saipan, American Samoa, Puerto Rico, the U.S. Virgin Islands and the other United States territories and protectorates with currently open safety or emissions recalls, or service campaigns. While TOYOTA provides data to Carfax Inc. on a regular basis, this report may not include very recent activity. For the manufacturer's most current information on recall/campaign activity for any Toyota, Lexus or Scion brand vehicle, you must go to <http://toyota.com/recall> or <http://lexus.com/recall>.

Follow Us:



[facebook.com/CARFAX](https://www.facebook.com/CARFAX)



[@CARFAXinc](https://twitter.com/CARFAXinc)



About CARFAX

CARFAX DEPENDS ON ITS SOURCES FOR THE ACCURACY AND RELIABILITY OF ITS INFORMATION. THEREFORE, NO RESPONSIBILITY IS ASSUMED BY CARFAX OR ITS AGENTS FOR ERRORS OR OMISSIONS IN THIS REPORT. CARFAX FURTHER EXPRESSLY DISCLAIMS ALL WARRANTIES, EXPRESS OR IMPLIED, INCLUDING ANY IMPLIED WARRANTIES OF MERCHANTABILITY OR FITNESS FOR A PARTICULAR PURPOSE.

SYSTEMATIC RETRIEVAL OF THE CONTENT OR OTHER DATA FROM THIS SITE TO CREATE OR COMPILE, DIRECTLY OR INDIRECTLY, IN WHOLE OR IN PART, A COLLECTION, COMPILATION, DATABASE OR DIRECTORY WITHOUT THE EXPRESS WRITTEN PERMISSION OF CARFAX IS STRICTLY PROHIBITED. BY USING THE CARFAX VEHICLE HISTORY REPORT YOU AGREE TO THE CARFAX TERMS OF USE AND PRIVACY STATEMENT.

© 2025 CARFAX, Inc., part of S&P Global. All rights reserved.  
9/6/25 3:09:10 PM (CDT)